

Product Information

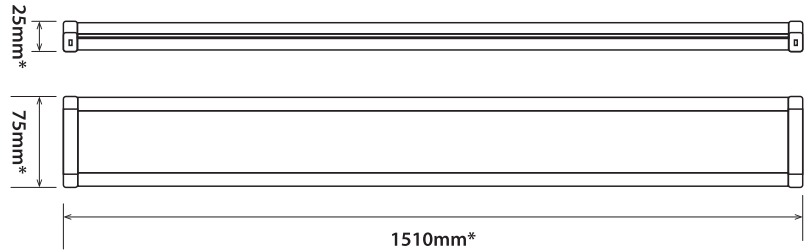

Technical Specifications

Model	Voltage	Power	Power Factor	Lumen (±5%)	Beam angle	CCT	Lifespan	CRI	Dimmable	Dimension
S15077	AC185-265V	45W	>0.9	4050	120°	4000K	25000h	>80	No	1510*75*25mm

Driver data Sheet

	DIM
Input rated Voltage	AC220-240V
Frequency	50/60Hz
Input Voltage	AC185-265V
Efficiency	85%
Total load Wattage	45±2W
Power Factor	>0.9
Rated input current	≤0.21
Full load output Voltage	75-90
Rated output current	255mA
Output current range	255mA±5%
Power tolerance	±5%
Current output tolerance	±5%
Withstand voltage	1500V
Short circuit protection	PASS
Overload protection	PASS
No-load protection	PASS

Fixture Compatibility

Rated Wattage	Electrical Classification	Ingress Protection	Operating Temp	Operating Humidity	Storage Temp
45W	I	IP20	-20°C-45°C	0-90%	-20°C-65°C

Spectral Distribution

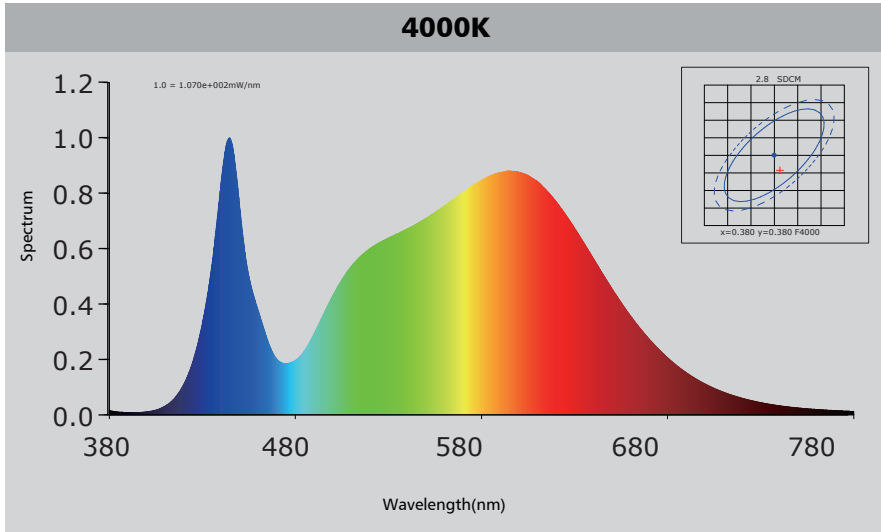

Photometric Diagram

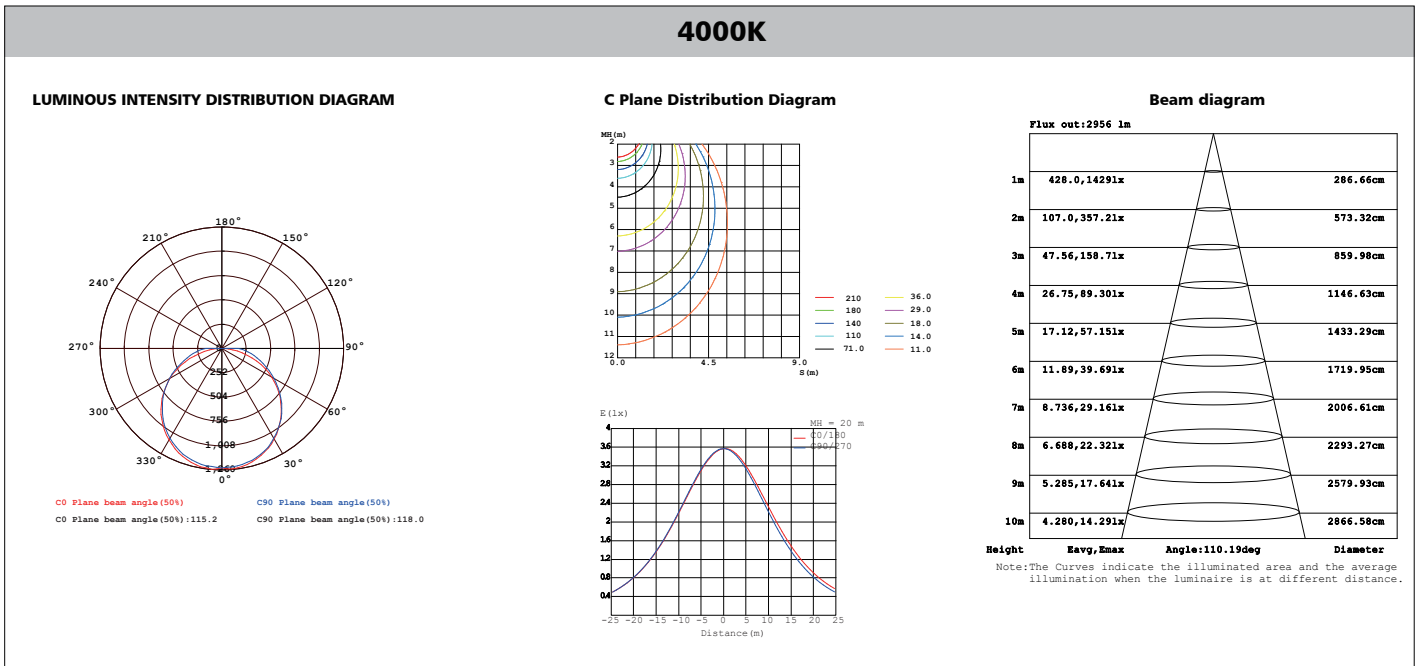

Polar Diagram Comparison

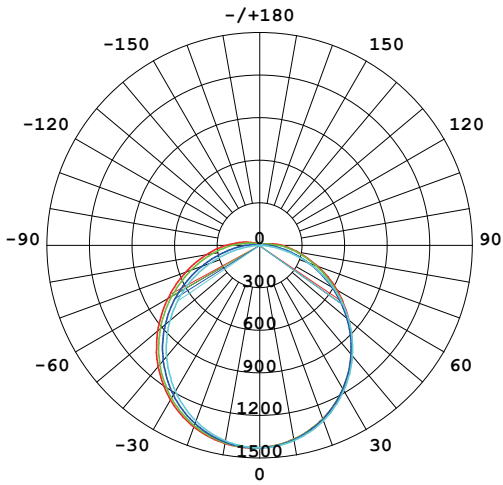

AVERAGE BEAM ANGLE (50%) : 113.4 DCE

Average Lumen Maintenance and Chromaticity Shift VS. Time

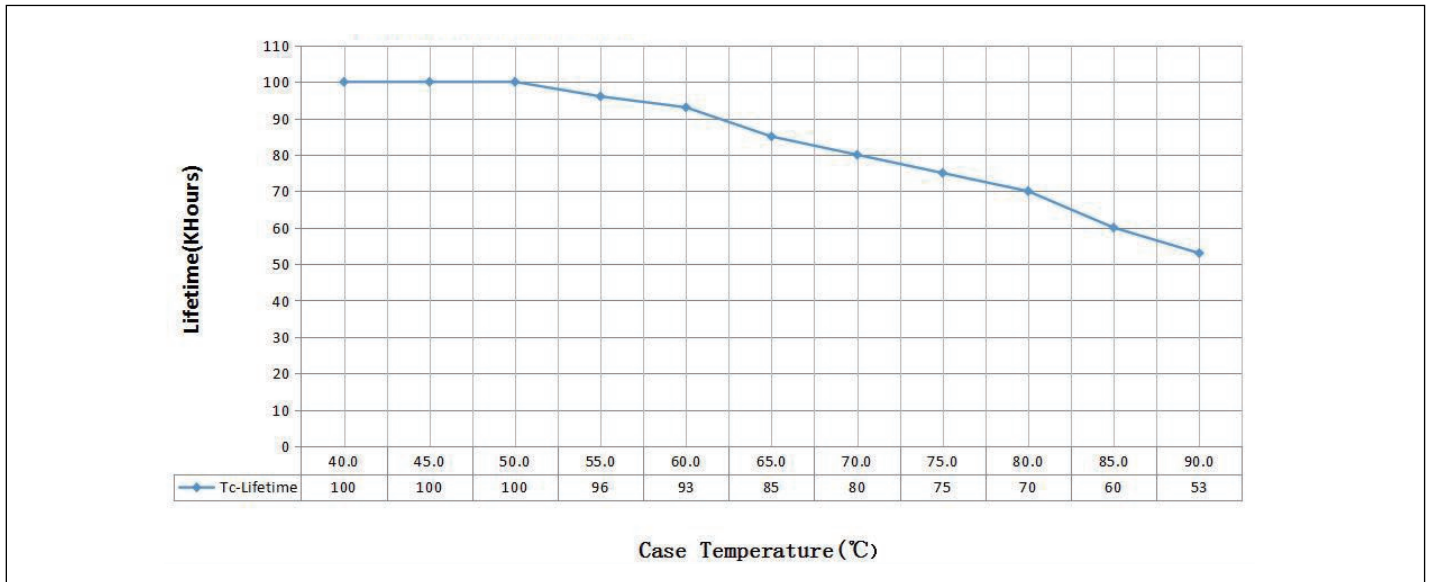

Installation

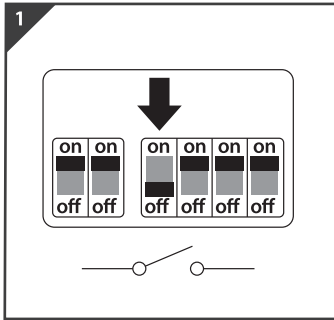

Switch OFF at mains supply before installing

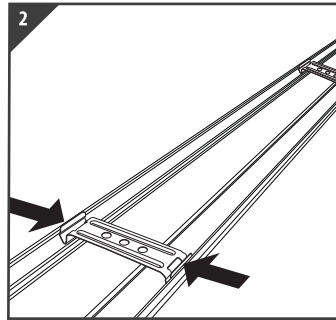

Compress the clip to remove from the fitting

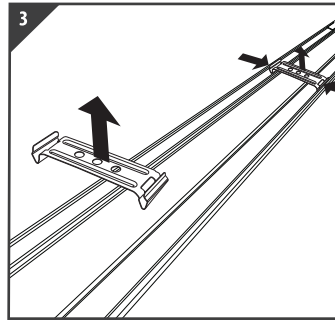

Remove all clips

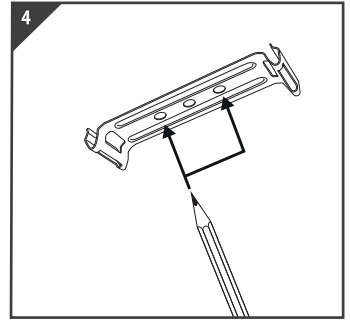

Mark the positioning for all the clips. Ensure alignment is perfectly straight.

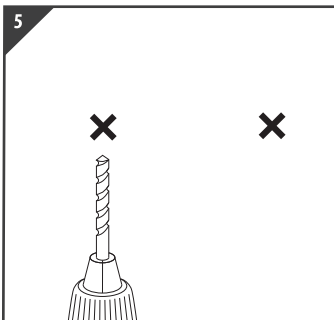

Use the correct sized drill bit and type for the mounting surface

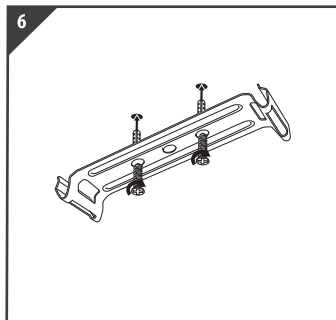

Secure brackets with the wall plugs and screws provided

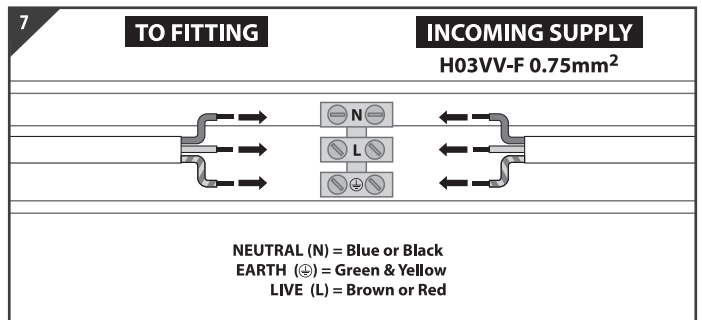

Insert correct supply (240 V/50Hz H03VV-F 0.75mm² core cable) and wiring from the fitting into terminal block (not provided), tighten all screws in block.

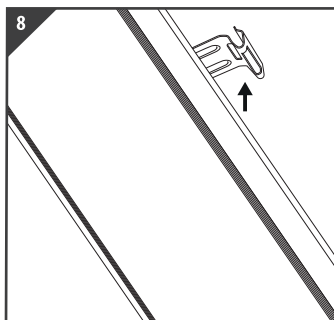

Push fitting onto the clips, these will click

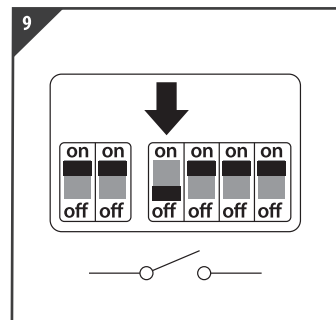

Return power. Switch ON at mains supply

Packaging Information

	SIZE(CM)	N.W/pc (KGS)	G.W.(KGS)	Q'TY(PCS)
Carton	153.5*32.5*18	0.62	13.5	20

	CTNS	Q'TY(PCS)	VOLUME(CBM)
20" standard container	311	6220	27.93
40" standard container	757	15140	67.98

